

Lemi[®]
ITALIAN WELLNESS EQUIPMENT



EVO

All EVO spa tables feature a mattress with HBS (Head Back Shoulder) system. This is the innovative system by which the head, the back and the shoulders can be stimulated without stretching and contractures, thanks to the possibility of lowering the armrests and adjusting the headrest.

Tutti i lettini EVO presentano il materasso con HBS (Head Back Shoulder) system, si tratta dell'innovativo sistema col quale testa, schiena e braccia possono essere stimolate senza stiramenti e contratture, grazie alla possibilità di abbassare i braccioli e regolare l'appoggiatesta.

EVO

VERONA EVO

VERONA EVO



* B: Rovere Wengé RW | M: Spa Prestige 1875



Chair position / Posizione poltrona

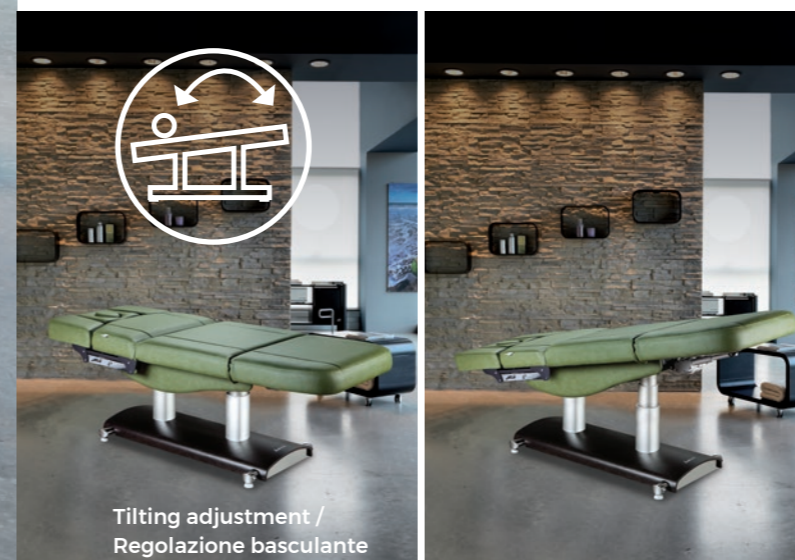

Tilting adjustment /
Regolazione basculante

COD. 816 EVO

Verona EVO, highly-advanced multifunctional Spa table that combines strength elegance of design with the exceptional comfort of the innovative mattress with HBS Stress Relief System. Thanks to its fully electric adjustment of height, backrest, legrest and tilting, the Verona EVO treatment table is DUAL USE: it can be used as a chair or as a bed, ideal for a wide range of Spa treatments, including facial&body and massages.

Verona EVO, lettino multifunzionale Spa altamente avanzato che combina la forza e l'eleganza del design con l'eccezionale comfort dell'innovativo materasso con HBS Stress Relief System. Grazie alla regolazione completamente elettrica dell'altezza, dello schienale, del poggiatesta e della basculante, il lettino Verona EVO è DUAL USE: può quindi essere utilizzato sia come poltrona che come lettino, ideale per una vasta gamma di trattamenti Spa, inclusi trattamenti viso&corpo e massaggi.

FROM BED
TO CHAIR

DA LETTINO
A POLTRONA

* The images are for illustrative purposes only and may not reflect the actual image of the finishing.

* Le immagini hanno valore puramente illustrativo e possono non rispecchiare l'immagine reale della finitura.

Focus on

- The HBS Stress Relief System ensures perfect ergonomics for the head, shoulders and back
- Mattress customizable in thickness and width upon request
- Fire retardant, "Azo" free, antibacterial and antifungal covering
- An ideal solution for multi-rooms
- Maximum client/practitioner comfort
- AUT function: automatic return from any position to zero position (flat and minimum height)
- END function: "End of treatment" position
- 4 electric adjustments for height, backrest, legrest and tilting allowing for DUAL USE
- Il Sistema anti-stress HBS garantisce perfetta ergonomia per testa, spalle e schiena
- Materasso personalizzabile in spessore e larghezza su richiesta
- Rivestimento Nefos ignifugo, "Azo" free, antibatterico, antimicotico
- Soluzione ideale per cabine multifunzionali
- Massimo comfort cliente / operatore
- Funzione AUT: ritorno automatico da ogni posizione alla posizione zero (piatto e altezza minima)
- Funzione END: posizione "fine del trattamento"
- 4 movimenti elettrici per regolazione di altezza, schienale, gamba e basculante che lo rendono DUAL USE

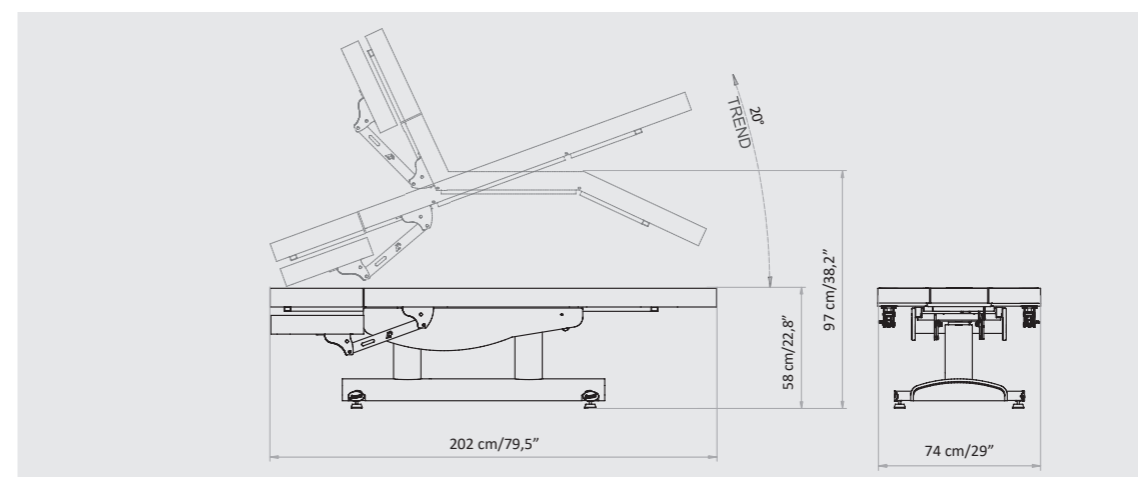

Packaging details

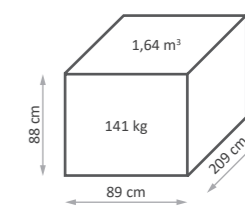

MAXIMUM CAPACITY
PORTATA MASSIMA
200 kg

MATTRESS CUSTOMIZATION

The innovative Spa Prestige and Nefos materials - which are exclusive for LEMI products - and their special finishing touch guarantee easy-cleaning and hygiene. Their extraordinary structural qualities will persist through the years. An incredibly elastic texture enhances the memory foam mattress softness and quality at its best, giving Spa Clients a complete and satisfying wellness experience.

PERSONALIZZAZIONE MATERASSO

Gli innovativi materiali Spa Prestige e Nefos - che sono un'esclusiva dei prodotti LEMI - ed il loro speciale tocco di finitura garantiscono una facile pulizia e igiene. Le loro straordinarie qualità strutturali permangono nel corso degli anni. Una texture incredibilmente elastica migliora al massimo la morbidezza e la qualità del materasso in Memory Foam, dando ai clienti Spa un'esperienza di benessere completa e soddisfacente.

SPA PRESTIGE COLORS

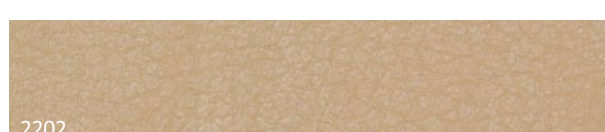
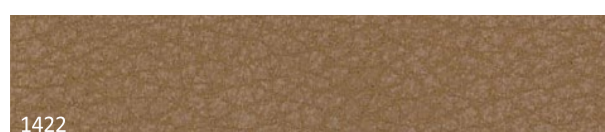
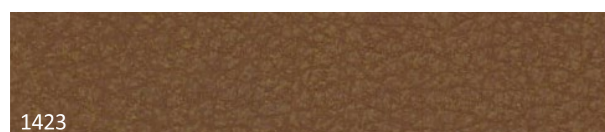
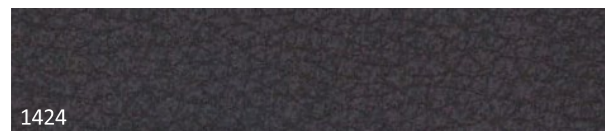

COLORI SPA PRESTIGE

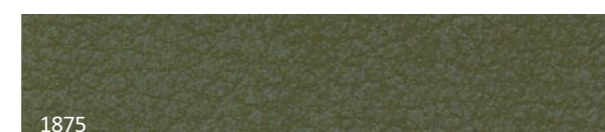
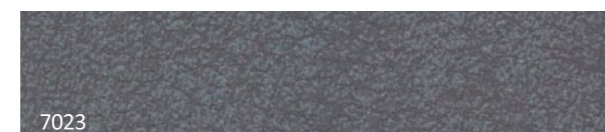
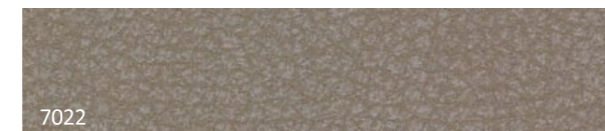

NEFOS COLORS

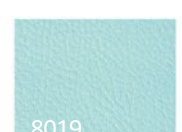
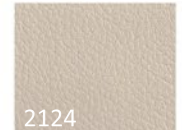
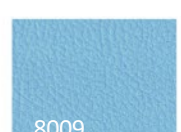
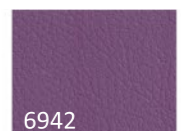
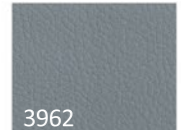
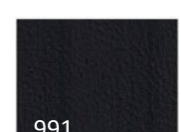
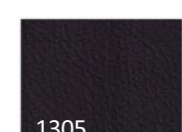
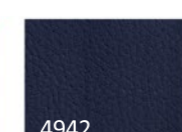
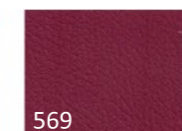
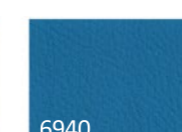
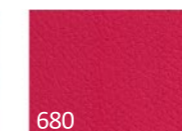
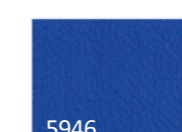

MATTRESS THICKNESS / SPESSORE MATERASSO



COMFORT - 9 CM / 3,5"

Mattress with high density foam for energetic massages

Materasso con gomma ad alta densità per massaggi energici



STANDARD EXTRA COMFORT - 12 CM / 4,7"

Comfortable mattress for relax massages

Materasso confortevole per massaggi relax

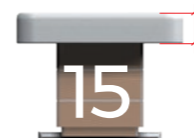

SUPER SOFT - 15 CM / 6" with Memory Foam

Super soft mattress with memory foam, available ONLY for 74 cm / 29" and 82 cm / 32,2" width.

Materasso super soft con memory foam, disponibile SOLO per larghezze 74 cm e 82 cm.

MATTRESS WIDTH / LARGHEZZA MATERASSO

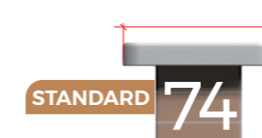

S - 74 CM / 29"

Width Standard - 74 cm / 29"
Larghezza Standard - 74 cm / 29"

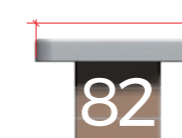

M - 82 CM / 32,2"

Width Medium - 82 cm / 32,2"
Larghezza Medium - 82 cm / 32,2"



L - 90 CM / 35,4"

Width Large - 90 cm / 35,4"
Larghezza Large - 90 cm / 35,4"

The images are for illustrative purposes only and may not reflect the actual finish of the product, particularly when viewed through a screen. Therefore, the **SELECTION OF THE FINISHES** of the bases and mattress **FABRICS** must take place **AFTER CONSULTING** the **LUXURY BOX PHYSICAL SAMPLES** and the NEFOS and SPA PRESTIGE **COLOR CHART**.

Le immagini hanno valore puramente illustrativo e possono non rispecchiare la finitura reale del prodotto, in particolare se visualizzate attraverso uno schermo. Pertanto la **SELEZIONE DELLE FINITURE** delle **BASI** e dei **RIVESTIMENTI** dei materassi deve avvenire **PREVIA CONSULTAZIONE** della **CAMPIONATURA FISICA** della **LUXURY BOX** e delle **CARTELLE COLORI** NEFOS e SPA PRESTIGE.

BASE CUSTOMIZATION

Today, 70% of the company's wooden equipment and treatment tables are manufactured using FSC certified lumber from unprotected forests. The woods are furnished by suppliers that have committed themselves to sustainable development, guaranteeing full compliance with the best environmental protection practices.

PERSONALIZZAZIONE BASE

Oggi, il 70% delle attrezzature e dei lettini in legno dell'azienda sono realizzati con legname certificato FSC proveniente da foreste non protette. I legni provengono da fornitori che si sono impegnati per lo sviluppo sostenibile, garantendo il pieno rispetto delle migliori pratiche di tutela ambientale.

Available finishing for VERONA EVO Finiture disponibili per VERONA EVO

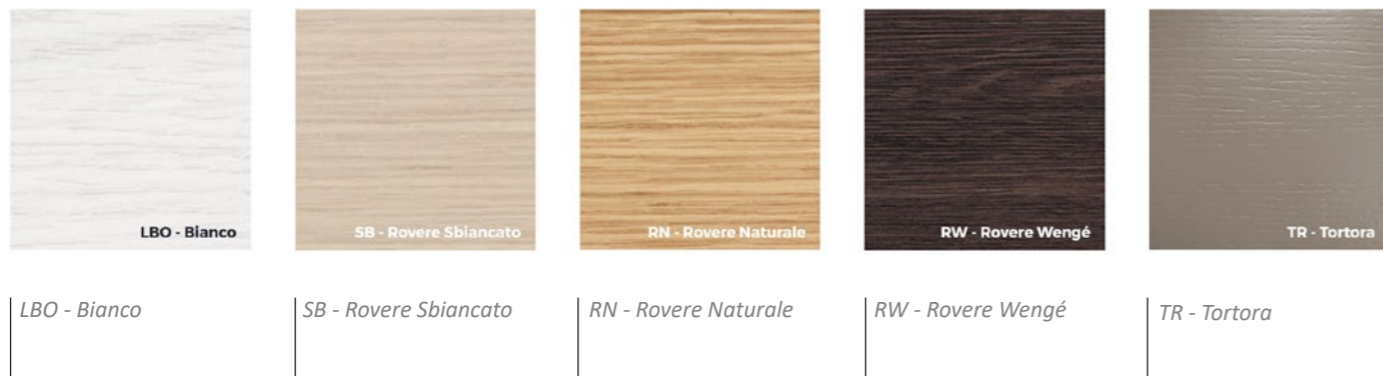

The images are for illustrative purposes only and may not reflect the actual finish of the product, particularly when viewed through a screen. Therefore, the **SELECTION OF THE FINISHES** of the bases and mattress **FABRICS** must take place **AFTER CONSULTING** the **LUXURY BOX PHYSICAL SAMPLES** and the NEFOS and SPA PRESTIGE **COLOR CHART**.

Le immagini hanno valore puramente illustrativo e possono non rispecchiare la finitura reale del prodotto, in particolare se visualizzate attraverso uno schermo. Pertanto la **SELEZIONE DELLE FINITURE** delle **BASI** e dei **RIVESTIMENTI** dei materassi deve avvenire **PREVIA CONSULTAZIONE** della **CAMPIONATURA FISICA** della **LUXURY BOX** e delle **CARTELLE COLORI** NEFOS e SPA PRESTIGE.

ACCESSORIES UPON REQUEST ACCESSORI SU RICHIESTA

All Evo beds have a standard setting customizable upon request.

Tutti i lettini Evo hanno una configurazione standard personalizzabile su richiesta.

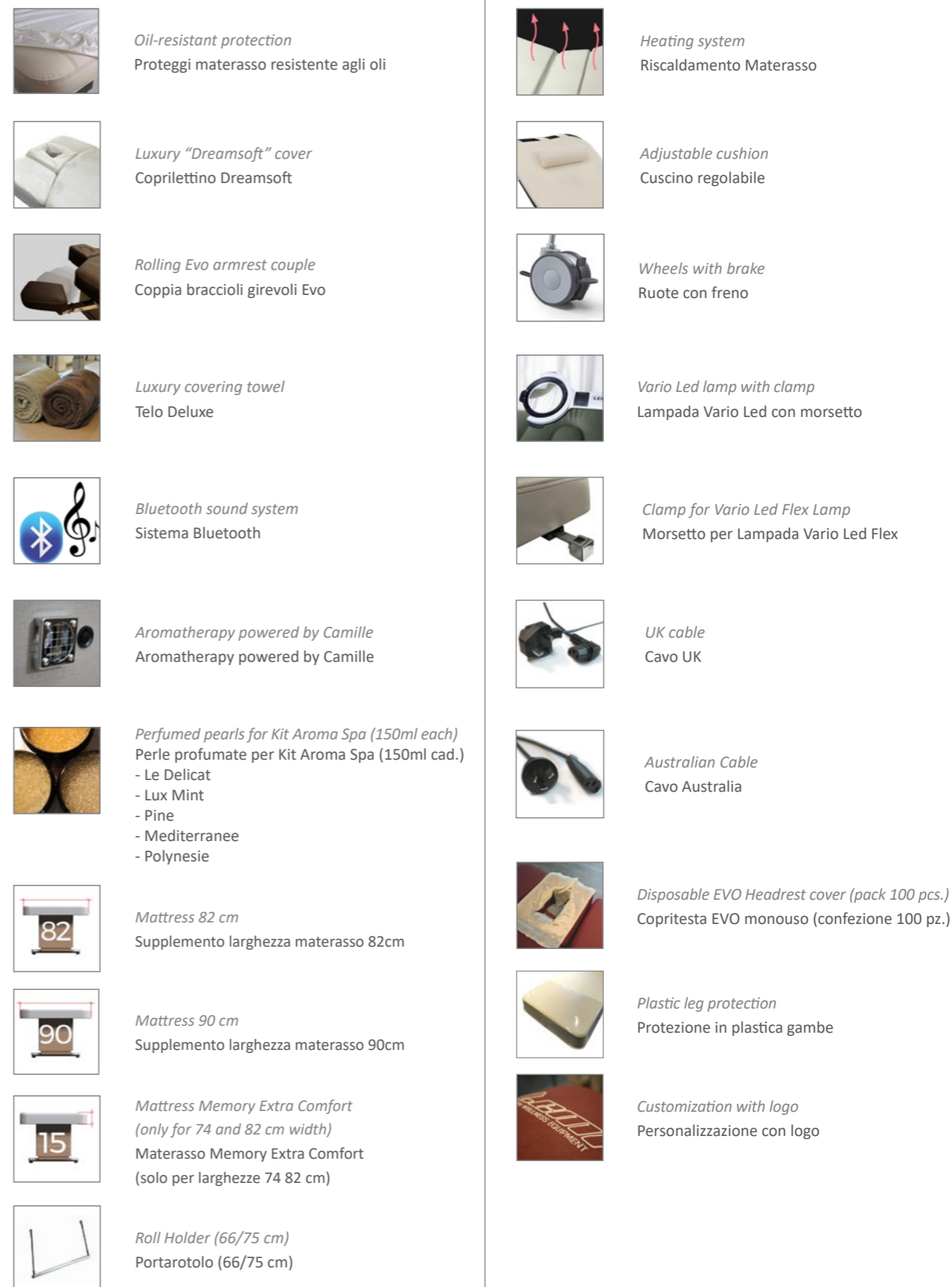

TECHNICAL REQUIREMENTS

CARATTERISTICHE TECNICHE

voltaggio <i>voltage</i>	frequenza <i>frequency</i>	assorbimento <i>absorption</i>	warranty	garanzia
240/100V ac	50/60 Hz	0,70-1,5 Amp	<i>Heating: 1 year Electric parts and controls: 3 years Undeformable foam: 5 years Actuators: 5 years Structure: Lifetime</i>	<i>Riscaldamento: 1 anno Parti elettriche e comandi: 3 anni Gomma indeformabile: 5 anni Attuatori: 5 anni Struttura: Lifetime</i>

REGULATIONS

All Equipment is  marked

Electrical equipment and beds

Directive 2006/42/CE (Machinery Directive) and national regulations

Directive 2014/30/UE (Electromagnetic Compatibility Directive) and national regulations.

Images

The images are for illustrative purposes only and may not reflect the actual image of the product.

NORME

Tutte le attrezzature sono a marchio 

Attrezzature e lettini elettrici

Direttiva 2006/42/CE (Direttiva Macchine) e disposizioni nazionali di attuazione

Direttiva 2014/30/UE (Direttiva Compatibilità elettromagnetica) e disposizioni nazionali di attuazione.

Immagini

Le immagini hanno valore puramente illustrativo e possono non rispecchiare l'immagine reale del prodotto.

Lemi[®]
ITALIAN WELLNESS EQUIPMENT

Brusaferrri & C srl

Via Mara Maretti Soldi, 13
26011 Casalbuttano (CREMONA) ITALY
Phone +39-0374-363069 Fax +39-0374-363071
info@lemigroup.it service@lemigroup.it

www.lemigroup.it